

TECHNICAL DATA SHEET

BALKEN G2 ELECTRIC CHAIN HOIST - SINGLE SPEED -
500KG CAPACITY

MODEL: DEH-3056



DESCRIPTION

Balken Generation 2 - Industrial Electric Chain Hoist is a single speed, 3 phase hoist, with a 500kg capacity. It features a 6 metre lift as standard.

FEATURES

- ❑ Balken Generation 2 Electric Chain Hoist manufactured for Stratalign by Delta Hoists, Netherlands.
- ❑ Built to European Standard Machinery Directive 2006/42/EC. Supplied with test certificate, CE declaration of conformity and operating instructions.
- ❑ Made to the EU Electrical Safety Standard BS EN 60204-32:2008
- ❑ Design Verified by NZ registered Chartered Professional Engineer.
- ❑ Robust aluminium housing.
- ❑ Compact hook to hook measurement.
- ❑ Hoist is IP55 rated and pendant control is IP65 rated.
- ❑ Swivel load hook.
- ❑ Electrical Control system with SIEMENS/EATON components for durability and quality.
- ❑ Permanently lubricated transmission, ensures smooth and quiet operation.
- ❑ Supplied with pendant control switch with e-stop, power cable and chain container.



09 263 7725 (Auckland)
03 222 2836 (Christchurch)



sales@stratalign.co.nz
www.stratalign.co.nz



6 Harbour Ridge Drive,
Wiri, Auckland, 2104

TECHNICAL DATA SHEET

BALKEN G2 ELECTRIC CHAIN HOIST - SINGLE SPEED - 500KG CAPACITY

MODEL: DEH-3056

SPECIFICATIONS

SPECIFICATIONS	
Operating Voltage	400V / 50Hz / 3Ph
Lifting Speed	8 m/min
Load Chain	Load chain according to EN 818-7-DAT/DT
Pendant Control Cable	6 metre
Power Cable	≈ 4.5 metre without plug
Hoist Protection	IP 55
Pendant Control Protection	IP 65
Classification	M5/2m (ISO/FEM)
Duty cycle / Starts per hour	40% / 240
Insulation Class	F
Operating Temperature	-10°C - +40°C

PROTECTION	
Control Switch	24V pendant control switch with emergency stop button
Overload Protection	Externally adjustable slip clutch
Brake	Electromagnetic spring pressure brake, holds the load in the event of power failure
Limit Switch	Electro-mechanical upper and lower limit switch
Thermal Protection	Protected through heat sensor

CAPACITY kg	LIFTING SPEED m/min	LOAD CHAIN Ømm	CHAIN FALLS	POWER OUTPUT kW	NET WEIGHT kg
500	8	5 x 15	1	0.72	33

OPTIONS



Remote Control
Two button - Single Speed
Easy Plug & Play Connection



Eye Suspension



Custom load chain and pendant
cable lengths available



Larger capacity chain buckets
available



TECHNICAL DATA SHEET

BALKEN G2 ELECTRIC CHAIN HOIST - SINGLE SPEED - 500KG CAPACITY

MODEL: DEH-3056



TECHNICAL DATA SHEET

BALKEN G2 ELECTRIC CHAIN HOIST - SINGLE SPEED - 500KG CAPACITY

MODEL: DEH-3056

DIMENSIONS

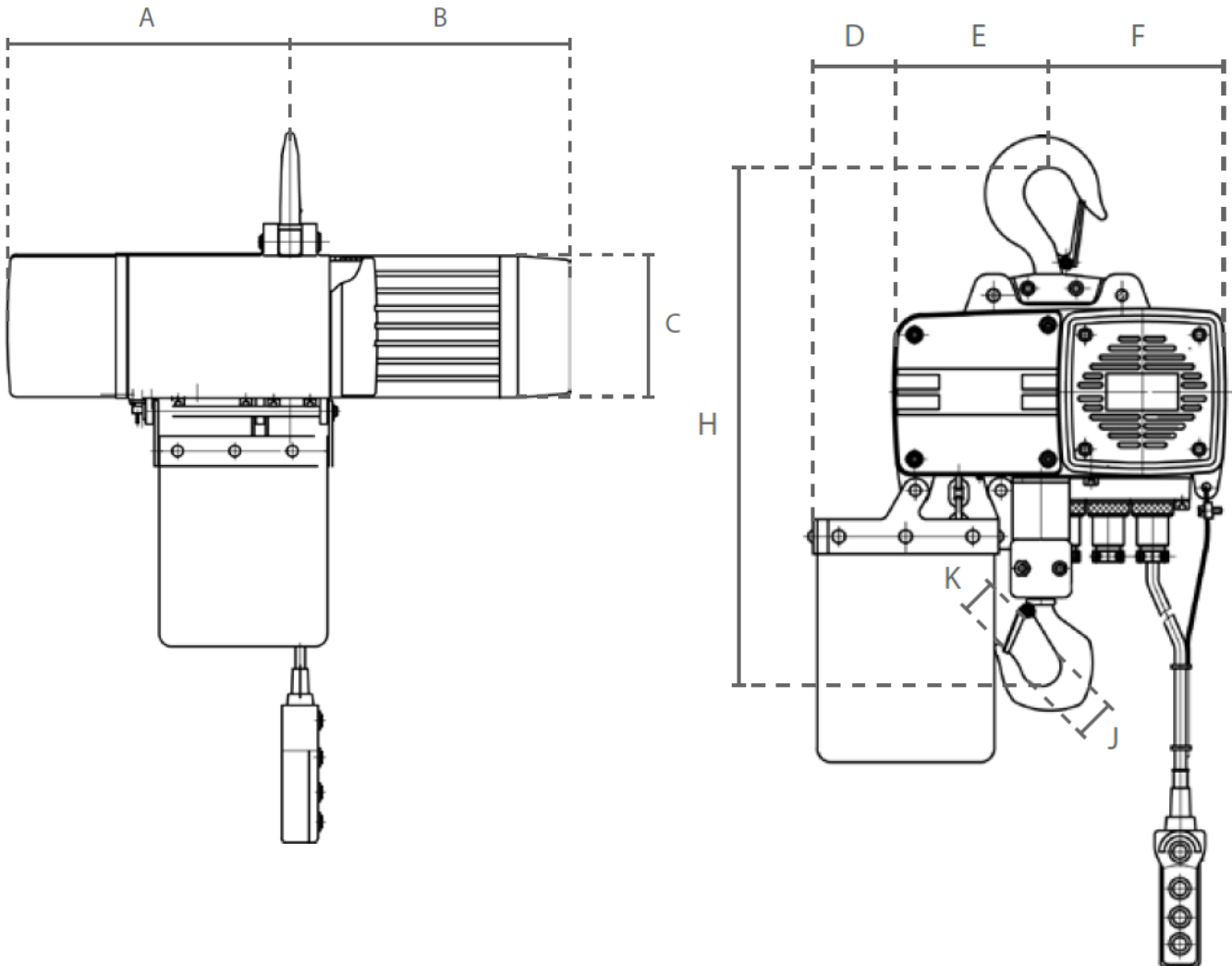

HOIST DIMENSIONS (MM)

A	B	C	D	E	F	H	J	K
231	204	165	62	118	162	465	40	27

